

Part number: SIM000079 - Model: SMF30-C10 NPN NO H

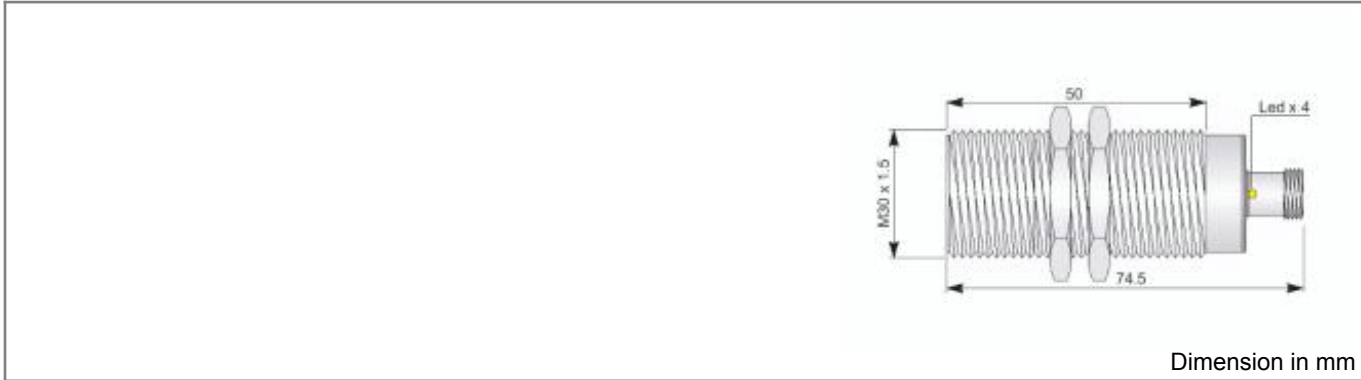

TECHNICAL CHARACTERISTICS	
Power supply:	Direct current
Working voltage:	10 ÷ 30 Vdc
Switching distance (mm):	10
Output logic:	NPN
Function:	NO
Hysteresis (%Sn):	< 20%
Max switching frequency:	50 Hz
Repeatability (%Sn):	< = 1
Max output current:	200 mA
Absorption:	< 2 mA @ 24Vdc
Voltage dro:	< 1.8 V
Short circuit protection:	Present
Led indicator:	Present
Temperature limits:	-25 ÷ +70 °C
IP rating:	IP68/IP69K
Housing material:	AISI316L
Mechanical characteristics:	M30x1.5
Connection type:	H plug
Weigth:	148 g



Part number: SIM000079 - Model: SMF30-C10 NPN NO H

WIRING DIAGRAM

CONNECTION WITH H PLUG

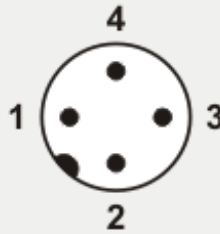
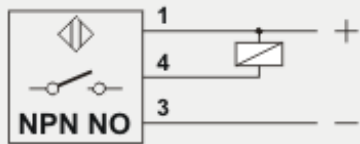

VIEW OF MALE CONNECTOR

- 1 = Brown / +
- 3 = Blue / -
- 4 = Black / output NO

INSTRUCTIONS FOR CORRECT INSTALLATION

INSTRUCTIONS FOR CORRECT INSTALLATION

EMBEDDABLE

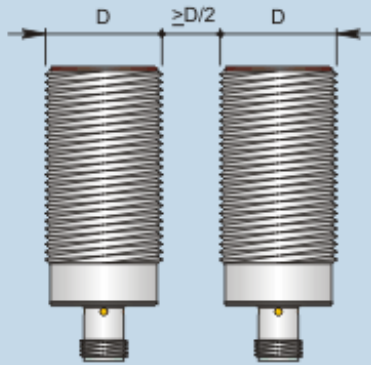

Side by side mounting

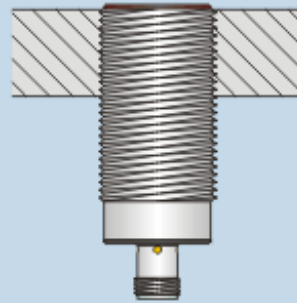

Flush mounting